

Article number: 20191B18B182BL

Description: E+G

T-angle clamps GN191-B18-B18-22-BL

Measures

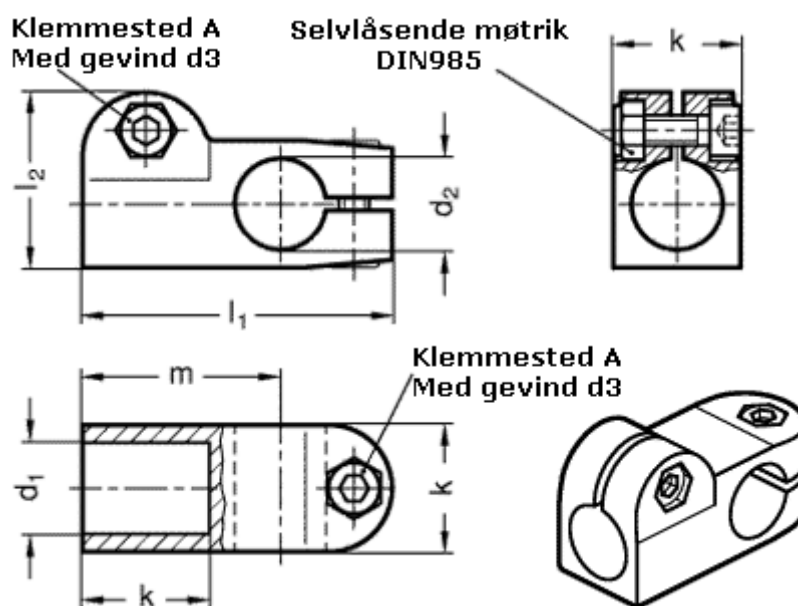

d1 = B18
d2 = B18
d3 = M 6
k = 25
l1 = 61
l2 = 34.5
m = 39